



CK65

Mobile Computer for use in Hazardous Locations

CK65 NI (CK65-LON-xxxxx1F)

CK65 ATEX (CK65-LON-xxxxx3A, CK65-LON-xxxxx3E,

CK65-LON-xxxxx3N)

Quick Start Guide



Introduction

This document is only for CK65 models marked as certified for use in hazardous environments. CK65 models intended for use in hazardous locations are identifiable by specific labeling on the back of the device.



Before you attempt to use, charge or replace the battery in the device, carefully read all labels, markings and product documentation provided in the box or online at sps.honeywell.com. To learn more about Battery Maintenance for Portable Devices, go to honeywell.com/PSS-BatteryMaintenance.

Avant d'essayer d'utiliser, de charger ou de remplacer la batterie de l'appareil, lisez attentivement toutes les étiquettes, marquages et documentation du produit fournis dans la boîte ou en ligne à sps.honeywell.com. Pour en savoir plus sur l'Entretien de Batteries pour Appareils Portables, consultez-le honeywell.com/PSS-BatteryMaintenance.

Out of the Box

Make sure that your shipping box contains these items:

- CK65 mobile computer
- Rechargeable 3.6 VDC Li-ion battery
- Hand strap
- I/O cover
- Product documentation

If you ordered accessories for your mobile computer, verify that they are also included with the order. Be sure to keep the original packaging in case you need to return the mobile computer for service.

Memory Card Specifications

Honeywell recommends the use of Single Level Cell (SLC) industrial grade microSD™ or microSDHC™ memory cards with mobile computers for maximum performance and durability.

Contact a Honeywell sales representative for additional information on qualified memory card options.

Equipment for Use in Hazardous Locations

Routine operator inspections should occur to check for possible device damage before using the mobile computer in areas known to be hazardous.



Caution: Improper battery replacement or incompatible device usage may result in risk of burns, fire, explosion, or other hazard. Dispose of batteries according to local regulations.

Mesee en garde: Le remplacement incorrect de la pile ou l'usage d'un appareil non compatible peut représenter des risques de brûlures, d'incendie, d'explosion ou d'autres dangers. Éliminez les piles lithium-ion usagées conformément aux réglementations locales.



Warning: Explosion Hazard - Batteries must only be changed or charged in an area known to be non-hazardous.

Use ONLY Honeywell CK65 battery part number 318-063-003 (Li-ion, 3.6 VDC).

Risqué d'explosion - Les batteries doivent uniquement être remplacées ou rechargées dans un endroit non dangereux.

Utilisez UNIQUEMENT Honeywell CK65 batterie P/N 318-063-003 (Li-ion, 3.6 VDC).



Do not remove the I/O cover in the hazardous area or attempt to make an I/O connection.

Ne pas retirer le capot E / S dans un environnement dangereux ni essayer de réaliser une connexion via les E / S dans un environnement dangereux.



Charging accessories and additional spare batteries must not be carried into the hazardous area.

Les accessoires de charge et les batteries de rechange supplémentaires ne doivent pas être transportés dans un environnement dangereux.



Warning: Explosion Hazard - Substitution of any components may impair suitability.

Avertissement: Risque d'explosion - La substitution de composants peut nuire à l'aptitude aux emplacements.



Warning: The device must be protected from impacts with high impact energy, permanent UV light emission and high electrostatic discharge processes.

Avertissement: L'appareil doit être protégé contre les chocs à haute énergie, les émissions permanentes de lumière UV, et les processus de décharge électrostatique élevée.

Mobile Computer Features

All Imagers

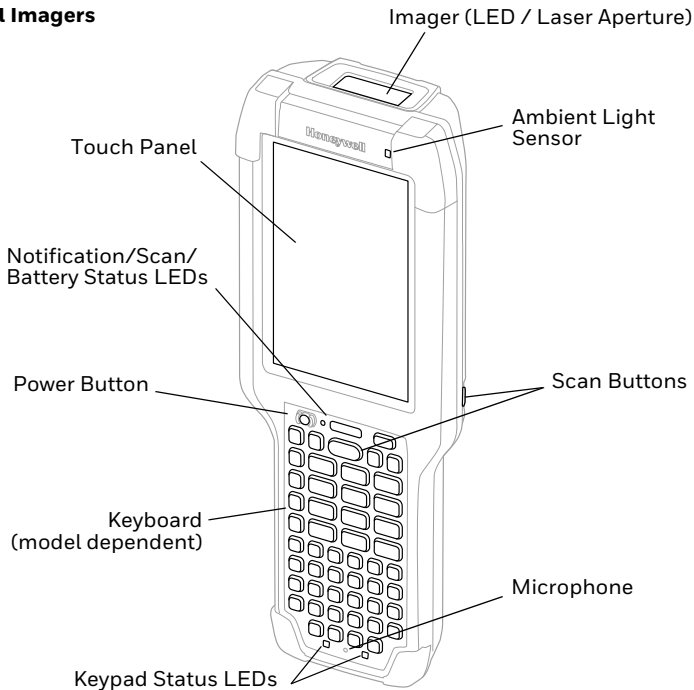

CK65 Model with S0803-LR/N6803-FR Imager

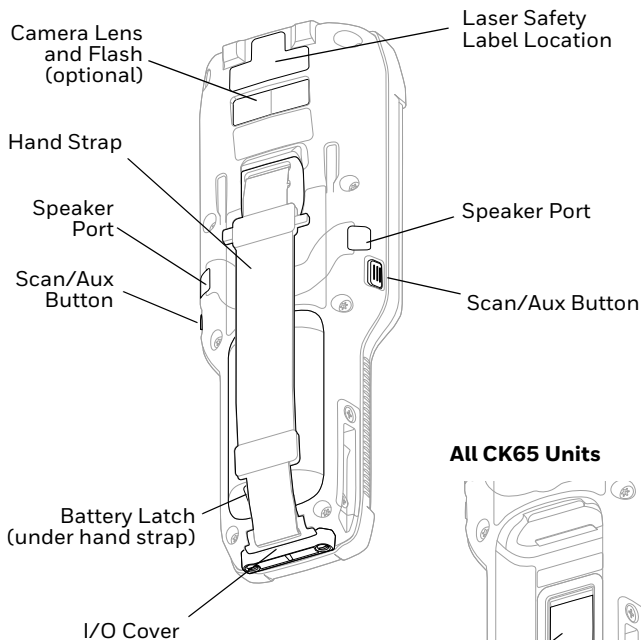

All CK65 Units

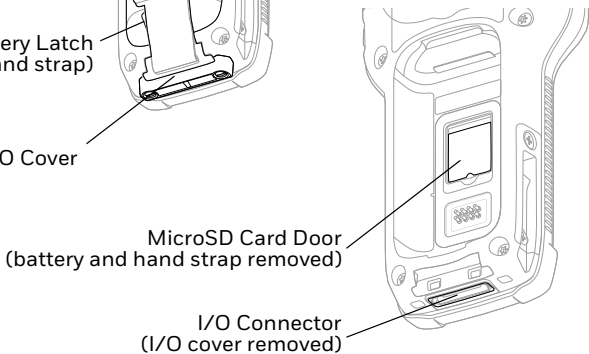

CK65 Model with EX20 Imager

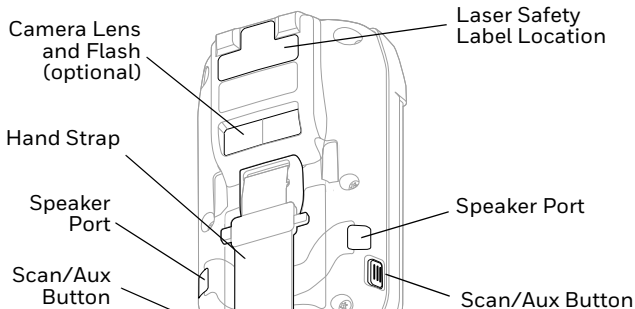

Battery Latch
(under hand strap)

I/O Cover

All CK65 Units

MicroSD Card Door
(battery and hand strap removed)

I/O Connector
(I/O cover removed)

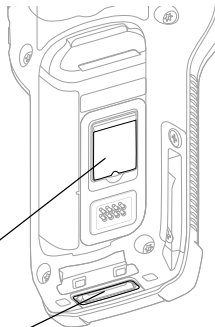

Install a microSD Card (Optional)



Always power off the computer before attempting to install or remove a card.

See "[Install the Battery](#)" for hand strap release information.

Format the microSD card before initial use.

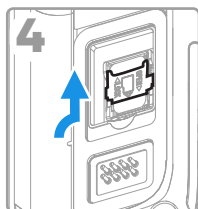
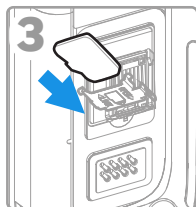
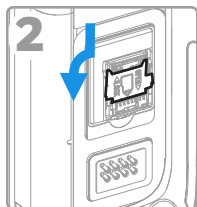
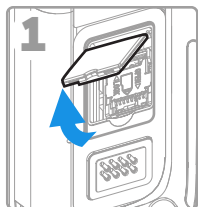

Install the Battery

The CK65 mobile computer ships with a Li-ion 3.6 VDC, 25.2 watt-hour battery manufactured for Honeywell International Inc.



Before you attempt to use, charge or replace the battery in the mobile computer, carefully read all the information under "Equipment for Use in Hazardous Locations".

Avant d'essayer d'utiliser, de charger ou de remplacer la batterie de l'ordinateur portable, lisez attentivement toutes les informations relatives aux "Equipment for Use in Hazardous Locations".

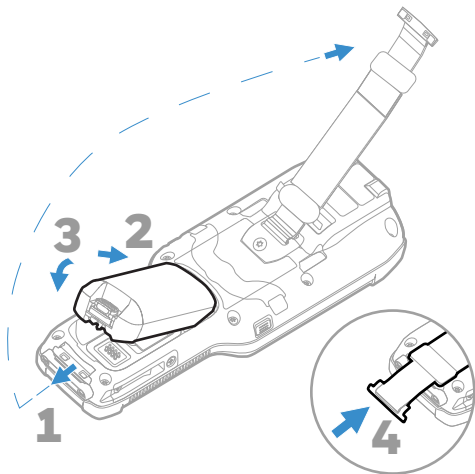



Ensure all components are dry prior to placing the battery in the computer. Mating wet components may cause damage not covered by the warranty.

Assurez-vous que tous les composants sont secs avant de placer la batterie dans l'ordinateur. L'insertion de composants humides risque de provoquer des dommages non couverts par la garantie.



Battery must be latched when using the CK65 in a hazardous environment.

AVERTISSEMENT: la batterie doit être verrouillée lors de l'utilisation du CK65 dans un environnement dangereux.

Charge the Mobile Computer



Before you attempt to use, charge or replace the battery in the mobile computer, carefully read all the information under "[Equipment for Use in Hazardous Locations](#)".

Avant d'essayer d'utiliser, de charger ou de remplacer la batterie de l'ordinateur portable, lisez attentivement toutes les informations relatives aux "[Equipment for Use in Hazardous Locations](#)".

The CK65 mobile computer ships with a partially charged battery. Charge the battery with a CK3 Series charging device for a minimum of **4 hours**. Using the computer while charging the battery increases the time required to reach a full charge.



We recommend the use of Honeywell accessories and power adapters. Use of any non-Honeywell accessories or power adapters may cause damage not covered by the warranty.

Mise en garde: Il est recommandé d'utiliser les périphériques, les cordons d'alimentation et les adaptateurs secteur conçus par Honeywell. L'utilisation de tout périphérique, cordon d'alimentation ou adaptateur secteur d'une autre marque est susceptible de provoquer des dommages non couverts par la garantie.

CK65 mobile computers are designed for use with CK3 Series charging accessories.



Ensure all components are dry prior to mating the computers and batteries with peripheral devices. Mating wet components may cause damage not covered by the warranty.

Mise en garde: Assurez-vous que tous les composants sont secs avant de connecter les terminaux/batteries à des périphériques. L'insertion de composants humides risque de provoquer des dommages non couverts par la garantie.

Remove the I/O Cover

Remove the I/O cover before inserting the CK65 into a charging dock:

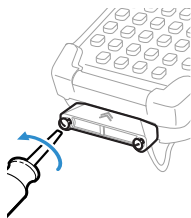

Warning: The I/O cover must be attached when using the CK65 in a hazardous environment.

Avertissement : Le couvercle entrée-sortie doit être fixé lorsque le CK65 est utilisé dans un environnement incendiaire.

Turn Power On/Off

The first time you power on the computer, a Welcome screen appears. You can either scan a configuration barcode or use the Wizard to manually set up the computer. Once setup is complete, the Welcome screen no longer appears on startup and Provisioning mode is automatically turned off (disabled).

To turn the computer on:

- Press and hold the **Power** button for approximately 3 seconds, and then release.

To turn the computer off:

1. Press and hold the **Power** button until the options menu appears.
2. Touch **Power off**.

Battery Replacement



Before you attempt to use, charge or replace the battery in the mobile computer, carefully read all the information under "**Equipment for Use in Hazardous Locations**".

Avant d'essayer d'utiliser, de charger ou de remplacer la batterie de l'ordinateur portable, lisez attentivement toutes les informations relatives aux "**Equipment for Use in Hazardous Locations**".

Hot Swap

You can replace the battery on demand provided the following conditions are met:

- The computer has been powered on for at least **4 minutes**.
- AND
- You insert a new battery within 30 seconds.

Swap Battery Mode

Swap Battery mode places the computer in a low power state so that the battery can be removed for a short time.

To activate Swap Battery mode:

1. Press and hold the **Power** button until the options menu appears.
2. Touch **Swap Battery** and follow the on-screen instructions.

Screen Timeout

Screen timeout automatically turns the touch panel display off and locks the computer to save battery power when the computer is inactive for a programmed period of time.



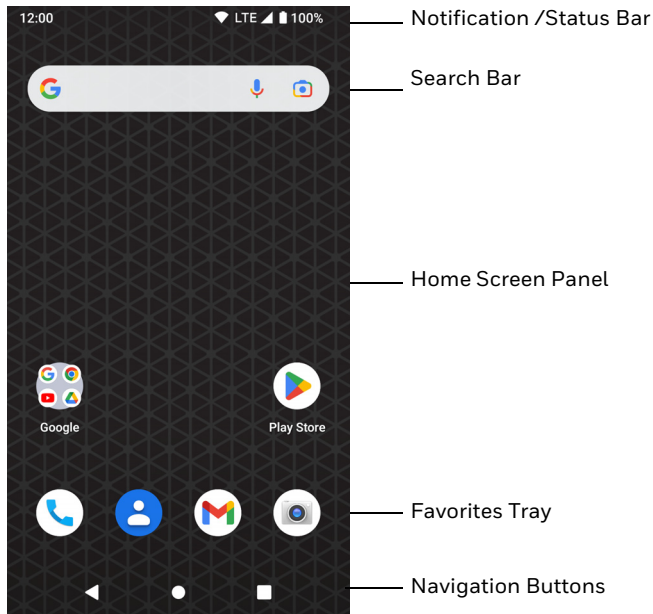

1. Press and release the **Power** button to wake the computer.
2. Swipe up from the bottom of the screen.

About the Home Screen



Navigation and Function Buttons

For button locations, see "[Mobile Computer Features](#)".

Button	Description	
	Back	Return to the previous screen.
	Home	Return to the Home screen.
	Recent Apps	View and switch between recently used apps.
	Scan	Press the right, left or front scan button to trigger the scanner.

About Provisioning Mode

After completing the out-of-box set up process, Provisioning mode is automatically turned off. Scanning a barcode to install applications, certificates, configuration files, and licenses on the computer is restricted unless you enable Provisioning mode in the Settings app. To learn more, see the user guide.

Scan a Barcode with the Scan Demo

Note: For optimum performance, avoid reflections by scanning the barcode at a slight angle.

1. Swipe up from the bottom of the Home screen to access all apps.
2. Touch **Demos** > **Scan Demo**.
3. Point the computer at the barcode.
4. Touch **Scan** on the touch screen or press and hold any **Scan** button. Center the aiming beam over the barcode.



The decode results appear on the screen.

Note: In the Scan Demo app, not all barcode symbologies are enabled by default. If a barcode does not scan, the correct symbology may not be enabled. To learn how to modify the default app settings, see the user guide.

Sync Data

To move files between your CK65 and a computer:

1. Connect the CK65 to your computer using a USB charge/communication accessory.
2. On the CK65, swipe down from the top of the screen to see the notifications panel.
3. Touch the Android System notification twice to open the options menu.
4. Select either **File Transfer** or **PTP**.
5. Open the file browser on your computer.
6. Browse to the CK65. You can now copy, delete and move files or folders between the computer and CK65 as you would with any other storage drive (e.g., cut and paste or drag and drop).

Note: *When Provisioning mode is turned off, some folders are hidden from view in the file browser.*

Restart the Mobile Computer

You may need to restart the mobile computer to correct conditions where an application stops responding to the system or the computer seems to be locked up.

1. Press and hold the **Power** button until the options menu appears.
2. Select **Restart**.

To restart the computer if the touch panel display is unresponsive:

- Press and hold the **Power** button for approximately 8 seconds until the computer restarts.

Note: *To learn about advanced reset options, see the user guide.*

Support

To search our knowledge base for a solution or to log in to the Technical Support portal and report a problem, go to honeywell.com/PSStechnicalsupport.

Documentation

Product documentation is available at sps.honeywell.com.

Limited Warranty

For warranty information, go to sps.honeywell.com and click **Support > Warranties**.

Patents

For patent information, see www.hsmpats.com.

Trademarks

Google, Android, Google Play and other marks are trademarks of Google LLC.

Disclaimer

Honeywell International Inc. (“HII”) reserves the right to make changes in specifications and other information contained in this document without prior notice, and the reader should in all cases consult HII to determine whether any such changes have been made. HII makes no representation or warranties regarding the information provided in this publication.

HII shall not be liable for technical or editorial errors or omissions contained herein; nor for incidental or consequential damages resulting from the furnishing, performance, or use of this material. HII disclaims all responsibility for the selection and use of software and/or hardware to achieve intended results.

This document contains proprietary information that is protected by copyright. All rights are reserved. No part of this document may be photocopied, reproduced, or translated into another language without the prior written consent of HII.

Copyright © 2022 Honeywell Group of Companies. All rights reserved.