



IH25-0

UHF RFID Reader

Quick Start Guide

Introduction

The IH25 UHF RFID Reader provides Ultra High Frequency (UHF) Radio Frequency Identification (RFID) connected to a mobile terminal. The unit can read and write to bar code, QR code and UHF RFID tags.

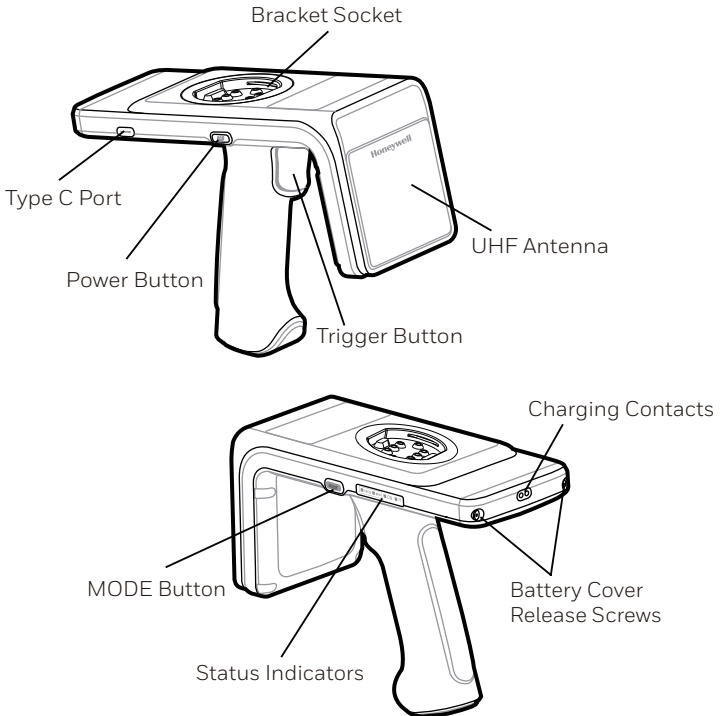

Battery Installation and Removal

Install the battery before using the reader for the first time.

1. To access the battery compartment, remove the battery cover screws and then the battery cover.

2. Insert the battery into the battery compartment with the tape at the bottom.

3. Attach the battery cover and tighten the screws. Note that the torque should be 3.5kg.f.

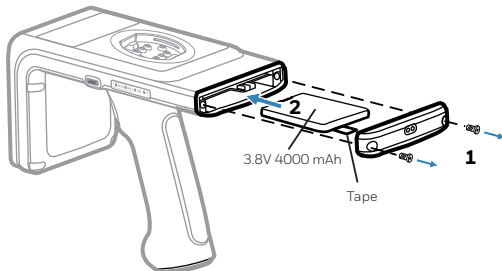

To uninstall the battery, remove the battery cover screws and then the battery cover. Pull the tape on the battery to pull the battery out.

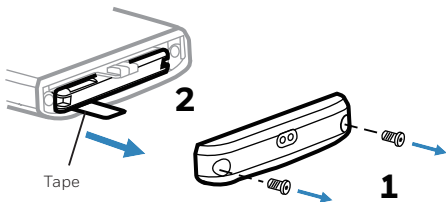

Charging

Before using the reader for the first time, ensure the battery is fully charged.

To charge the reader, use the USB cable + AC charge adapter (Honeywell recommended) or a docking station.

Solid amber: Charging
Solid green: Fully charged

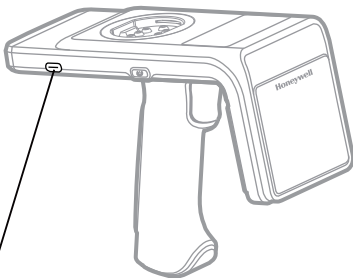

AC Charge

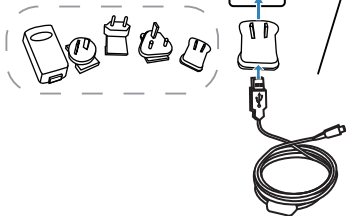

Docking Station Charge

Use the one slot or four-slot docking station to charge IH25 and the mobile terminal. **Note:** when charging, make sure the charging indicator is always on.

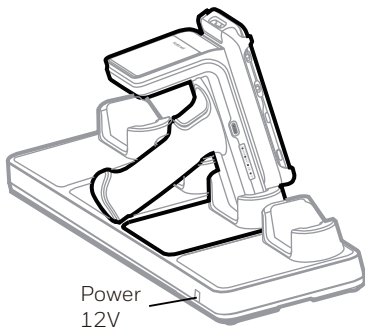
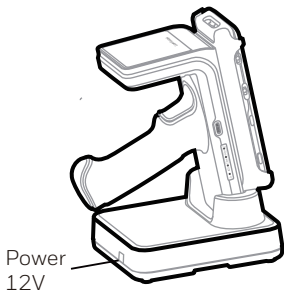

Fitting/Unloading Device Case and Attaching Device

1. Insert the mobile terminal into the bracket and press it down.

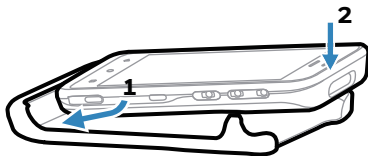

Note: When installing the bracket, pay attention to the angle and strength so as not to damage the product.

2. Check the bracket on the bottom of the case and the socket on the reader are clean and free from dirt or debris.

3. Align the bracket with the socket, ensuring that it is parallel, and press the two parts together firmly until they click into place.

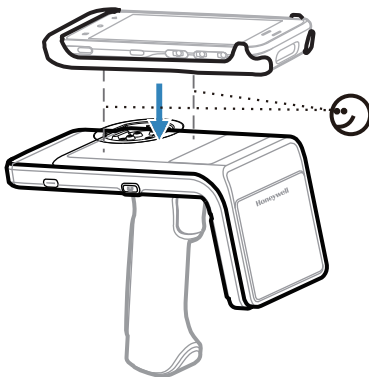

4. Unload the mobile terminal: place the IH25 on the table or hold it at the sides with both hands, push the buckle out with your thumbs, and lift the terminal out with your index finger.

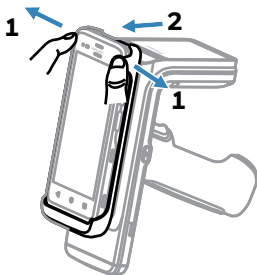

5. Unload the bracket: hold the handle with one hand and lift it from the side of the bracket with other hand.

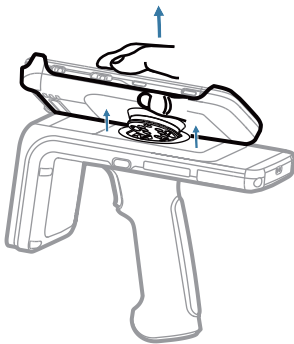

Reading RFID Tags

1. Turn on power to the reader and it beeps one time. Power on the mobile terminal and launch HONRFID APP . Touch the Connect icon on Home Screen to go to the Connect screen.

Auto Connect

- a. Tap Auto Connect to switch on this function.
- b. Tap Search Button and the mobile device will search for the available Bluetooth device and connect to it automatically. It beeps one time when successfully connected.
- c. Tap CREATE READER at the bottom of the screen to pair with IH25 and go to the Scan screen.

Manually Connect

- a. Tap Auto Connect to switch it off.
- b. Tap Search Button and wait till the available Bluetooth devices are displayed in the list.
- c. Select IH25 to connect and it beeps one time when successfully connected.
- d. Tap CREATE READER at the bottom of the screen to pair with IH25 and go to the Scan screen.

QR Code Connect

Tap  on the right top corner of Connect screen and select Barcode Way to scan the QR code on IH25 to pair with it.

2. Press MODE button and release within 3 seconds to check IH25's operation mode. If RFID LED lights up, it means IH25 works in RFID mode; If 1D/2D LED lights up, it means IH25 works in Barcode mode. Press and hold the MODE button for at least 3 seconds to switch to RFID mode.

3. Press the trigger button to read tags.

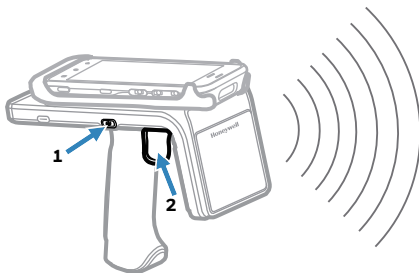

Note

- The Barcode Way is only supported by Honeywell's mobile device.
- Make sure to switch on the Bluetooth function and Location (Settings > Security & location> Location) on mobile before connecting. Otherwise, the connection fails all the time.
- RFID tags can be read when they are in range. The range (typically 0.2ft–20ft) at which a tag can be read depends on the tag type and size and the number of tags in the field.

MODE Button and Status Indicators

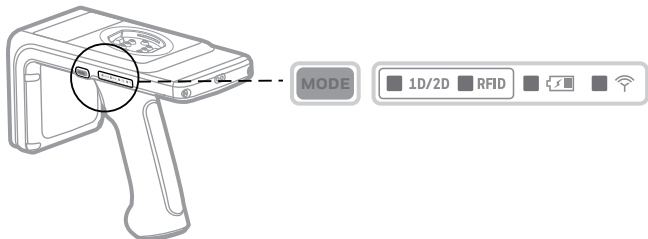

MODE

1D/2D RFID

Press the MODE button to light on the current mode light.
Release the button within 3 seconds, the mode light is off.
Press and hold the MODE button for at least 3 seconds to switch between 1D/2D and RFID mode and the current mode light is on.
Release the button, the current mode light is off.



Solid amber: Charging
Solid green: Fully charged
Red flash/ Green and amber flash alternately: Charge error
Solid red: Battery low warning (<20% capacity remaining.)



Blue slow flash: Bluetooth disconnected (two beeps when disconnect from PDA)
Solid blue: Bluetooth connected (one beep when connected successfully)

Important Safeguards

- We recommend the use of Honeywell accessories and power adapters. Use of any non-Honeywell accessories or power adapters may cause damage not covered by the warranty.
- We recommend use of Honeywell Li-ion battery packs. Use of any non-Honeywell battery may result in damage not covered by the warranty.
- Ensure all components are dry prior to mating the unit and batteries with peripheral devices. Mating wet components may cause damage not covered by the warranty.
- Ensure all components are dry prior to placing the battery in the unit. Mating wet components may cause damage not covered by the warranty.

Support

To search our knowledge base for a solution or to log into the Technical Support portal and report a problem, go to www.hsmcontactsupport.com.

User Documentation

For the user guide and other documentation, go to www.honeywellaidc.com.

Limited Warranty

For warranty information, go to www.honeywellaidc.com and click Get Resources > Product Warranty.

Patents

For patent information, see www.hsmpats.com.

Trademarks

The Bluetooth® word mark and logos are owned by Bluetooth SIG, Inc.

Other product names or marks mentioned in this document may be trademarks or registered trademarks of other companies and are the property of their respective owners.

Disclaimer

Honeywell International Inc. (“HII”) reserves the right to make changes in specifications and other information contained in this document without prior notice, and the reader should in all cases consult HII to determine whether any such changes have been made. The information in this publication does not represent a commitment on the part of HII.

HII shall not be liable for technical or editorial errors or omissions contained herein; nor for incidental or consequential damages resulting from the furnishing, performance, or use of this material. HII disclaims all responsibility for the selection and use of software and/or hardware to achieve intended results.

This document contains proprietary information that is protected by copyright. All rights are reserved. No part of this document may be photocopied, reproduced, or translated into another language without the prior written consent of HII.

Copyright © 2018 Honeywell International Inc. All rights reserved.