



CBX100 LT Installation Manual

The CBX100 LT is a connection box which can be used as an accessory to facilitate system connections for installation and device replacement of several Datalogic family reading devices specifically designed to be used in subzero temperature applications.

System cabling is made through spring clamp terminal blocks inside the CBX100 LT while the reading device is connected to the CBX100 LT through a 25-pin connector on the housing.

A 9-pin connector placed inside the CBX100 LT facilitates connection between an external PC and the auxiliary serial interface of the reading device for configuration or data monitoring.

GENERAL VIEW



Figure A

- 1 Indicator LEDs
- 2 Cover Screws (2)
- 3 Compression Connectors (4)
- 4 25-pin Device Connector
- 5 Subzero logo

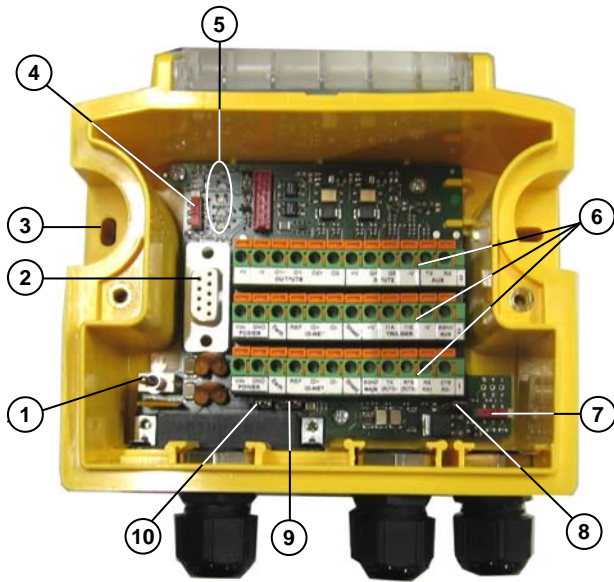

Figure B

- 1 Power switch (ON/OFF)
- 2 Auxiliary Port Connector
- 3 Mounting Holes (2)
- 4 ID-NET™ Termination Resistance Switch
- 5 Indicator LEDs
- 6 Spring Clamp Terminal Blocks
- 7 RS485 Termination Resistance Switch
- 8 Power Source Selector
- 9 Shield to Protection Earth Selector
- 10 Chassis Grounding Selector

SAFETY PRECAUTIONS

ATTENTION: READ THIS INFORMATION BEFORE INSTALLING THE PRODUCT

POWER SUPPLY

This product is intended to be installed by Qualified Personnel only.
This device is intended to be supplied by a UL Listed NEC Class 2 power source.



Total power consumption is given by adding the CBX100 LT power consumption to that of all the devices powered through the CBX100 LT (reading device, P.S., I/O). Refer to the manual of the connected devices for details about minimum/maximum supply voltage and power consumption.

Each CBX100 LT supports only 1 single reading device + system accessories.

OPENING THE CBX100 LT

To install the CBX100 LT or during normal maintenance, it is necessary to open it by unscrewing the two cover screws:



The CBX100 LT must be disconnected from the power supply during this operation.
Installation must be made at a temperature not lower than -20 °C.

MECHANICAL INSTALLATION

CBX100 LT can be mounted to various wooden or plastic surfaces using the two self-threading screws (3.9 x 45 mm) and washers provided in the package.

Mounting to other surfaces such as concrete walls or metallic panels requires user-supplied parts (screws, screw anchors, nuts, etc). A mounting template is included in the package to facilitate hole drilling alignment.

CBX100 LT can also be mounted to a DIN rail or a Bosch Frame using the following mounting accessories: BA100 (93ACC1821), BA200 (93ACC1822).

The diagram below gives the overall dimensions of the CBX100 LT and shows the two mounting through-holes.

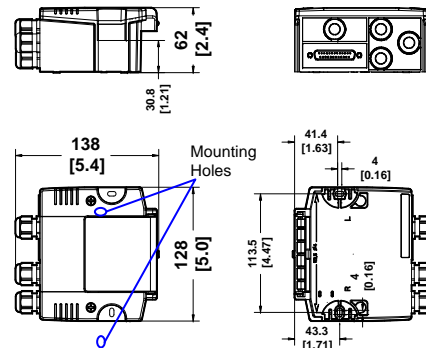

Figure 1 - Overall Dimensions

ELECTRICAL CONNECTIONS AND SETUP

The following figure shows a typical layout.

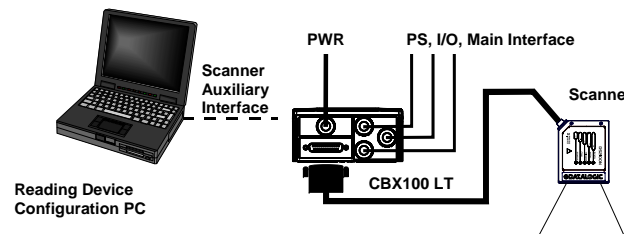

Figure 2 - System Layout

The dotted line in the figure refers to an optional (temporary) hardware configuration in which a portable PC can be quickly connected to the CBX100 LT (and consequently to the reading device auxiliary interface) through the internal 9-pin connector. This allows monitoring of the data transmitted by the reading device or configuration through the utility program (see the reading device Installation Manual for more details). The reading device auxiliary interface signals are also available on the internal spring clamp connectors.

After making system cabling and switch settings, connect the reading device to the 25-pin connector on the CBX100 LT housing.
Switch ON the CBX100 LT power switch (see Figure 3). The Power LED lights (blue) when the power connection has the correct polarity. The Power LED lights (red) in case of wrong polarity.
After system functioning has been verified, close the CBX100 LT using the 2 cover screws.

POWER SUPPLY

Power is supplied to the CBX100 LT through the Vdc and GND pins provided on the spring clamp connector.

The power switch (see Figure 3) switches the power supply ON or OFF for both the CBX100 LT and the connected reading device.



The power switch does not control power to the Vdc/GND, +V/-V spring clamps, therefore any devices connected to these signals (i.e. external trigger, encoder, etc.), are live and are not protected from polarity inversion. Disconnect the power supply when working inside the CBX100 LT.

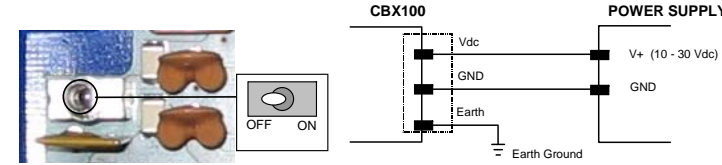

Figure 3 - Power Switch ON/OFF Positions and Connections



Vdc is electrically connected to +V, just as GND is electrically connected to -V. This is useful for supplying external trigger, inputs and outputs from the CBX100 LT power source, however +V and -V signals should not be used as power supply inputs to the CBX100 LT.

Although the CBX100 LT can be powered between 10 and 30 Vdc, the Subzero readers require 24 Vdc ± 10%.



To avoid electromagnetic interference:

- Connect CBX100 LT Protection Earth (Earth) to a good earth ground.
- Connect the reading device chassis to earth ground through the jumper, (default setting, see Figure 7).
- Connect the Network Cable Shield (Shield) to Filtered Earth through the jumper (default setting, see Figure 6).

SYSTEM WIRING

The connection and wiring procedure for CBX100 LT is described as follows:

- 1) Open the CBX100 LT by unscrewing the 2 cover screws.
 - 2) Verify that the CBX100 LT power switch is off (see Figure 3).
 - 3) Unscrew the compression connectors and pass all the system cables through them into the CBX100 LT housing.
 - 4) To connect the power and input/output signals:
 - Prepare the individual wires of the system cables by stripping the insulation back approximately 1 cm.
 - Using a device such as a screwdriver, push down on the lever directly next to the clamp (see Figure 4).
 - Insert the wire into the clamp and release the lever.
- The wire will now be held in the spring clamp.
- 5) Tighten the compression connector nuts so that the internal glands seal around the cables.

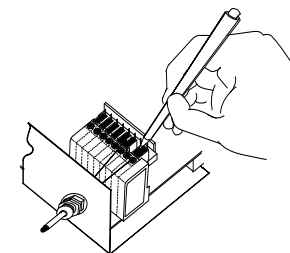

Figure 4 - System Cable Connections

Flexible stranded wire should be used and must meet the following specifications.

All positions: 24 - 16 AWG 0.2 - 1.5 mm²

The CBX100 LT spring clamp connector pinouts are indicated in the Pinout table. Refer to the reading device Installation Manual for signal details.

| Pinouts | | | | |
|------------------------|--------|---|---------|---------|
| Group | Name | Function | | |
| Input Power | Vdc | Power Supply Input Voltage + | | |
| | GND | Power Supply Input Voltage - | | |
| | Earth | Protection Earth Ground | | |
| External Trigger Input | +V | Power Source - External Trigger | | |
| | I1A | External Trigger A (polarity insensitive) | | |
| | I1B | External Trigger B (polarity insensitive) | | |
| Generic Input | -V | Power Reference - External Trigger | | |
| | +V | Power Source - Inputs | | |
| | I2A | Input 2 A (polarity insensitive) | | |
| Outputs | I2B | Input 2 B (polarity insensitive) | | |
| | -V | Power Reference - Inputs | | |
| | +V | Power Source - Outputs | | |
| Auxiliary Interface | -V | Power Reference - Outputs | | |
| | O1+ | Output 1 + | | |
| | O1- | Output 1 - | | |
| | O2+ | Output 2 + | | |
| ID-NET™ | O2- | Output 2 - | | |
| | TX | Auxiliary Interface TX | | |
| | RX | Auxiliary Interface RX | | |
| Network | SGND | Auxiliary Interface Reference | | |
| | REF | Network Reference | | |
| Main Interface | ID+ | ID-NET™ Network + | | |
| | ID- | ID-NET™ Network - | | |
| Network | Shield | Network Cable Shield | | |
| | | RS232 | RS485FD | RS485HD |
| | | TX | TX+ | RTX+ |
| | | RTS | TX- | RTX- |
| Main Interface | | RX | *RX+ | |
| | | CTS | *RX- | |
| | | SGND | SGND | SGND |

The input power signals Vdc, GND and Earth as well as the network signals REF, ID+, ID- and Shield are repeated to facilitate system cabling. In this way the power and network busses can enter and exit the CBX100 LT from different spring clamps but be physically connected together.

POWER SOURCE JUMPER SETTINGS

For subzero applications input power is provided through the dedicated spring clamp connectors inside the CBX100 LT. Make sure that the Power source jumper is in the default position as shown in the figure below.

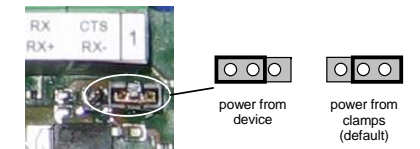

Figure 5 - Power Source Jumper Settings

SHIELD TO PROTECTION EARTH JUMPER SETTINGS

The network cable shield (Shield) can be connected to Earth Ground (Earth) either directly or through a filter circuit. If the jumper is left open, the network cable shield (Shield) is floating.

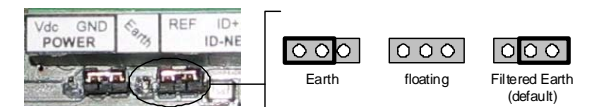

Figure 6 - Shield to Protection Earth Jumper Settings

CHASSIS GROUNDING JUMPER SETTINGS

The reading device chassis grounding method can be selected by positioning a jumper (see Figure 7). In this way the reading device chassis can be connected to earth ground (only if pin Earth is connected to a good earth ground). The reading device chassis can alternatively be connected to the power supply ground signal (GND) or it can be left floating but, in this case, the jumper must be removed.

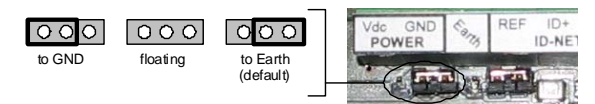

Figure 7 - Chassis Grounding

9-PIN READING DEVICE AUXILIARY SERIAL INTERFACE

The reading device auxiliary serial interface available on the internal CBX100 LT 9-pin connector can be used either for configuration or for data monitoring. Connections can be made to a PC or Laptop using a straight through cable or a USB-RS232 converter.

The details of the connector pins are indicated in the following table:

| CBX100 LT 9-pin D-Sub Female Connector Pinout | | |
|---|------|----------------------------|
| Pin | Name | Function |
| 2 | TX | Auxiliary RS232 |
| 3 | RX | Auxiliary RS232 |
| 5 | SGND | Auxiliary Reference Ground |
| 1, 4, 6, 7, 8, 9 | | N.C. |

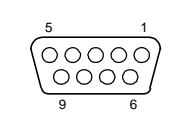

NETWORK BUS TERMINATION

ID-NET™



Figure 8 – ID-NET™ Termination Resistance Switch

The ID-NET™ termination resistance switch enables or disables the insertion of the bus termination resistor for ID-NET™ network applications.



In ID-NET™ network applications the termination resistor must be enabled **ONLY** on the first and last devices of the chain. On all the other devices this resistor **MUST NOT** be enabled (OFF).

RS485 HD

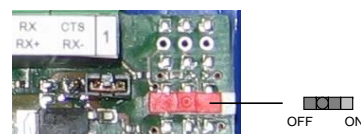

Figure 9 – RS485 HD Termination Resistance Switch

Make sure the termination resistance switch is in the OFF position (default).

INDICATOR LEDS

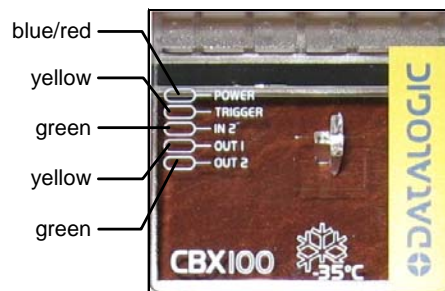

Figure 10 – Indicator LEDs

There are five Indicator LEDs which signal power and I/O activity and are visible from the CBX100 LT outside cover.

The Power LED is blue when power is correctly applied to the CBX100 LT and the power switch is turned on.

This LED is red if power polarity is incorrect. In this case the connected reading device and optional Backup Module are protected.



If external I/O devices are powered through CBX100 LT (connected to +V/-V), they are not protected from polarity inversion.

The remaining four LEDs signal activity on the relative I/O lines. Their meaning depends on the software configuration of the connected reading device.

TECHNICAL FEATURES

| ELECTRICAL FEATURES | |
|---|--|
| Supply Voltage | 10 to 30 Vdc * |
| Consumption | 0.5 to 0.3 A |
| Limited Current Consumption CBX + reading device consumption (see related manual) | 2.5 A Max |
| Inputs | Non opto-isolated polarity insensitive 30 Vdc max; 12 mA max |
| Outputs | Opto-isolated polarity sensitive 30 Vdc max; 40 mA max continuous 130 mA max pulsed |
| USER INTERFACE | |
| LED Indicators | Power On/Polarity Error (blue/red) Trigger (yellow) IN2 (green) OUT1 (yellow) OUT2 (green) |
| PHYSICAL FEATURES | |
| Mechanical Dimensions | 138 x 128 x 62 mm (5.4 x 5 x 2.4 in.) |
| Weight | about 380 g. (13.40 oz.) |
| ENVIRONMENTAL FEATURES | |
| Operating Temperature | -35° to 50 °C (-31° to 122 °F) ** |
| Storage Temperature | -35° to 70 °C (-31° to 158 °F) |
| Humidity max. | 90% non condensing |
| Vibration Resistance | 14 mm @ 2 to 10 Hz EN 60068-2-6 1.5 mm @ 13 to 55 Hz 2 hours on each axis 2 g @ 70 to 200 Hz |
| Shock Resistance | 30 g; 11 ms; EN 60068-2-27 3 shocks on each axis |
| Protection Class | IP65 (when compression connectors and reading device are correctly connected) |

* for further details about minimum/maximum supply voltage refer to the manual of the connected reading device, since the minimum supply voltage required may be >10 (i.e. 24 Vdc ± 10% for Subzero readers).

** Installation must be made at a temperature not lower than -20 °C.

BACKUP AND RESTORE (ALL-IN-ONE MODELS ONLY)

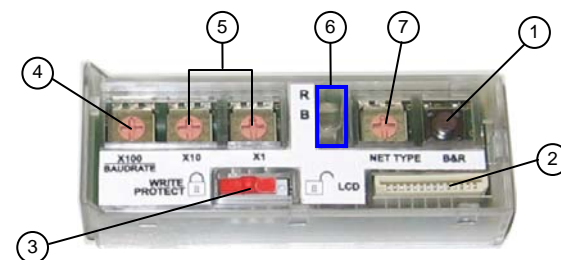

Figure 11 General View

- ① Backup/Restore Button
- ② Display Connector (not used)
- ③ Write Protection Lock
- ④ ID-NET™ Baudrate Switch
- ⑤ ID-NET™ Address Switches
- ⑥ Backup/Restore Indicator LEDs
- ⑦ Network Type Switch

The CBX100 LT all-in-one models contain the BM100 Backup Module which provides the following functions:

- Backup and Restore
Complete Configuration and Environmental parameter storage for ID-NET™ network and reading devices. Includes write protection.
- Network Address Selection
Hardware Address selection for the ID-NET™ Slave devices (overrides software configuration).
- Network Type Selection
Selection of the ID-NET™ Slave type networking (depends on the application).

BACKUP AND RESTORE PROCEDURE

The backup and restore functions are valid for any application layout type (point-to-point or ID-NET™ network) using CBX100 LT all-in-one model connection boxes. They can be performed by:

- the **Genius™ Device Menu** commands (always).
- the **BM100 button**, (if Fam2/4K scanner X-PRESS™ *Key Functionality* parameter is enabled)

If it ever becomes necessary to replace the reading device it can be quickly configured through the restore procedure.

BM100 provides complete backup and restore functions (Configuration and Environmental parameters) and cannot be interrupted once started (LED quickly blinking).

- For network nodes, the backup module of the ID-NET™ Master saves the configuration of all the reading devices in the network, Master and all individual Slaves. **The Slaves must be configured with the same network baudrate as the Master before performing the Restore procedure.**

- For single reading device stations, Slaves, or for RS232 Master/Slave networks, the backup module saves the configuration only of the specific connected reading device.

These functions are cyclical every 3 seconds:

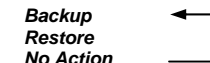

To perform **Backup**:

- Make sure the Write Protection switch is unlocked.
- Press and hold the Backup & Restore button for approximately 3 seconds. The green Backup LED (B) lights up.
- Release the button to select Backup **and within 1 second** press and release it again to activate the procedure. The green Backup LED (B) blinks quickly indicating the backup procedure is active. At the end of the procedure **both B and R LEDs turn on for about 2 seconds**. When the LEDs turn off the procedure is complete.
- Set the Write Protection switch to locked.

To perform **Restore**:

- Press and hold the Backup & Restore button for approximately 6 seconds. The yellow Restore LED (R) lights up.
- Release the button to select Restore **and within 1 second** press and release it again to activate the procedure. The yellow Restore LED (R) blinks quickly indicating the restore procedure is active. At the end of the procedure **both B and R LEDs turn on for about 2 seconds**. When the LEDs turn off the procedure is complete.

To exit without performing Backup or Restore procedures do one of the following:

- Release the button while both LEDs are off (**No Action**)
- After releasing the button the first time, do not re-press the button to activate the procedure but wait about 3 seconds (timeout during which the relative LED blinks slowly).

NETWORK TYPE SELECTION

The network type depends on the application layout.

| Net Type Switch |
|---|
| 0 = None (no network present) or ID-NET™ Master |
| 1 - 7 = Not Available |
| 8 = ID-NET™ Slave Synchronized |
| 9 = ID-NET™ Slave Multidata |

The Net Type selector switch allows setting the ID-NET™ network:

- ID-NET™ Masters communicating with the Host through the main serial interface, and all other non network applications must be set to **None (0)**.
- If used for ID-NET™ Slaves, this switch must be set to **Slave Synchronized (8)** or **Slave Multidata (9)** depending on the ID-NET™ network Topology Role (same as Master).

NETWORK ADDRESS SELECTION

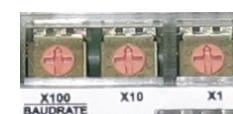

Figure 12 – Address Selection Switches

BM100 provides hardware network address selection for rapid installation of ID-NET™ networks. These switch settings are read at each power-up or reset, and override software configuration settings.

The valid selection range for the ID-NET™ Slave addresses is from 01 to 31. Address selections outside of this range are not accepted by the ID-NET™ network. The x100 switch refers to the ID-NET™ baudrate.

BAUDRATE SELECTION

When the BM100 is used for ID-NET™ network Slaves, the ID-NET™ baudrate is selected through the baudrate switch and must match the Master ID-NET™ baudrate. The settings are:

| ID-NET™ Baudrate Switch | | |
|-------------------------|----------------|---------------|
| | 0 = 19200 Baud | 5 = 500 kBaud |
| | 1 = 38400 Baud | 6 = 1 MBaud |
| | 2 = 57600 Baud | 7 = Reserved |
| | 3 = 125 kBaud | 8 = Reserved |
| | 4 = 250 kBaud | 9 = Reserved |

SEARCH FOR BACKUP MEMORY AT DEVICE STARTUP

This reader configuration parameter is enabled by default, so that at startup, the reader sends a message to recognize the presence of, and communicate with, the Backup Module. If using the CBX100 LT all-in-one model, this parameter must be enabled.

WRITE PROTECTION LOCK



Figure 13 – Write Protection

A write protection switch is provided to protect configuration data from being inadvertently overwritten. When this switch is in the lock position, the Backup function is not available (data cannot be written to the backup memory) and a diagnostic warning message can be sent. The Restore function is available.

SUPPORT THROUGH THE WEBSITE

Your product Reference Manual including installation procedures is available for download on our website as well as the configuration program. Datalogic provides several services as well as technical support through its website. Log on to www.datalogic.com and click on the **SUPPORT > Unattended Scanning Systems** category link. From this page you can select your product model from the dropdown list which gives you access to: Downloads including Data Sheets, Manuals, Software & Utilities, and Drawings; **Repair Program** for On-Line Return Material Authorizations (RMAs) plus Repair Center contact information; **Service Program** containing details about Maintenance Agreements; **Technical Support** through email or phone.

CE COMPLIANCE

CE marking states the compliance of the product with essential requirements listed in the applicable European directive. Since the directives and applicable standards are subject to continuous updates, and since Datalogic promptly adopts these updates, therefore the EU declaration of conformity is a living document. The EU declaration of conformity is available for competent authorities and customers through Datalogic commercial reference contacts. Since April 20th, 2016 the main European directives applicable to Datalogic products require inclusion of an adequate analysis and assessment of the risk(s). This evaluation was carried out in relation to the applicable points of the standards listed in the Declaration of Conformity. Datalogic products are mainly designed for integration purposes into more complex systems. For this reason it is under the responsibility of the system integrator to do a new risk assessment regarding the final installation.

Warning: This is a Class A product. In a domestic environment this product may cause radio interference in which case the user may be required to take adequate measures.

FCC COMPLIANCE

Modifications or changes to this equipment without the expressed written approval of Datalogic could void the authority to use the equipment. This device complies with PART 15 of the FCC Rules. Operation is subject to the following two conditions: (1) This device may not cause harmful interference, and (2) this device must accept any interference received, including interference which may cause undesired operation. This equipment has been tested and found to comply with the limits for a Class A digital device, pursuant to part 15 of the FCC Rules. These limits are designed to provide reasonable protection against harmful interference when the equipment is operated in a commercial environment. This equipment generates, uses, and can radiate radio frequency energy and, if not installed and used in accordance with the instruction manual, may cause harmful interference to radio communications. Operation of this equipment in a residential area is likely to cause harmful interference in which case the user will be required to correct the interference at his own expense.

EAC COMPLIANCE

Customs Union: The CU Conformity certification has been achieved; this allows the Product to bear the Eurasian mark of conformity.

LEGAL NOTICES

© 2008 – 2017 Datalogic S.p.A. and/or its affiliates • ALL RIGHTS RESERVED. • Without limiting the rights under copyright, no part of this documentation may be reproduced, stored in or introduced into a retrieval system, or transmitted in any form or by any means, or for any purpose, without the express written permission of Datalogic S.p.A. and/or its affiliates. Datalogic and the Datalogic logo are registered trademarks of Datalogic S.p.A. in many countries, including the U.S. and the E.U. ID-NET is a trademark of Datalogic S.p.A. and/or its affiliates. All other trademarks and brands are property of their respective owners.

Datalogic shall not be liable for technical or editorial errors or omissions contained herein, nor for incidental or consequential damages resulting from the use of this material.